

Wariant LEWY
Variant L

Wariant PRAWY
Variant R

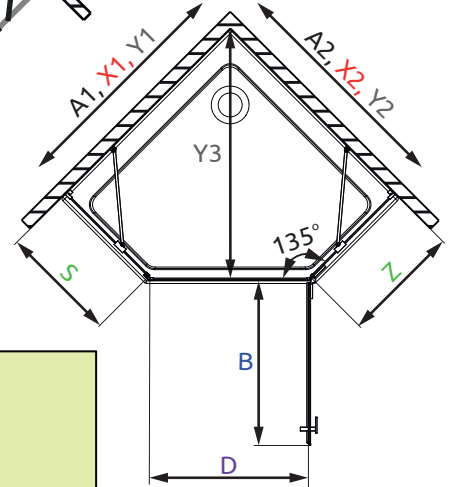
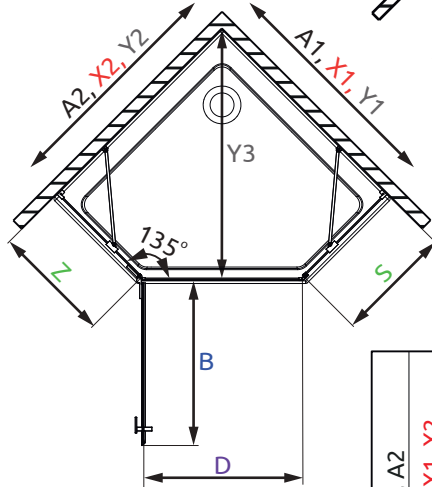

Wariant LEWY / Variant L

Wariant PRAWY / Variant R

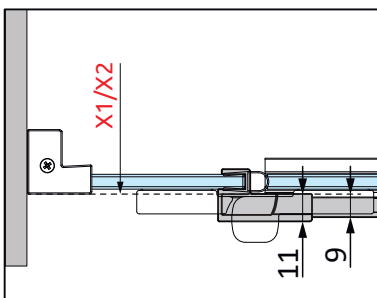
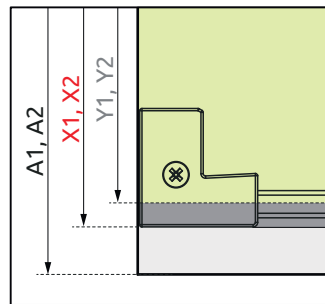

Model	A1	A2	X1	X2	Y1	Y2	Y3	B	Z	S	D	H
PTJ 80Zx80S	800	800	772-787	772-787	767-782	767-782	778-799	620	340-355	335-350	600	2000
PTJ 90Zx90S	900	900	872-887	872-887	867-882	867-882	919-940	620	440-455	435-450	600	2000
PTJ 100Zx100S	1000	1000	972-987	972-987	967-982	967-982	1061-1082	620	540-555	535-550	600	2000
PTJ 80Zx90S	800	900	772-787	872-887	767-782	867-882	849-870	620	340-355	435-450	600	2000
PTJ 80Zx100S	800	1000	772-787	972-987	767-782	967-982	919-940	620	340-355	535-550	600	2000
PTJ 90Zx80S	900	800	872-887	772-787	867-882	767-782	849-870	620	440-455	335-350	600	2000
PTJ 90Zx100S	900	1000	872-887	972-987	867-882	967-982	990-1011	620	440-455	535-550	600	2000
PTJ 100Zx80S	1000	800	972-987	772-787	967-982	767-782	919-940	620	540-555	335-350	600	2000
PTJ 100Zx90S	1000	900	972-987	872-887	967-982	867-882	990-1011	620	540-555	435-450	600	2000

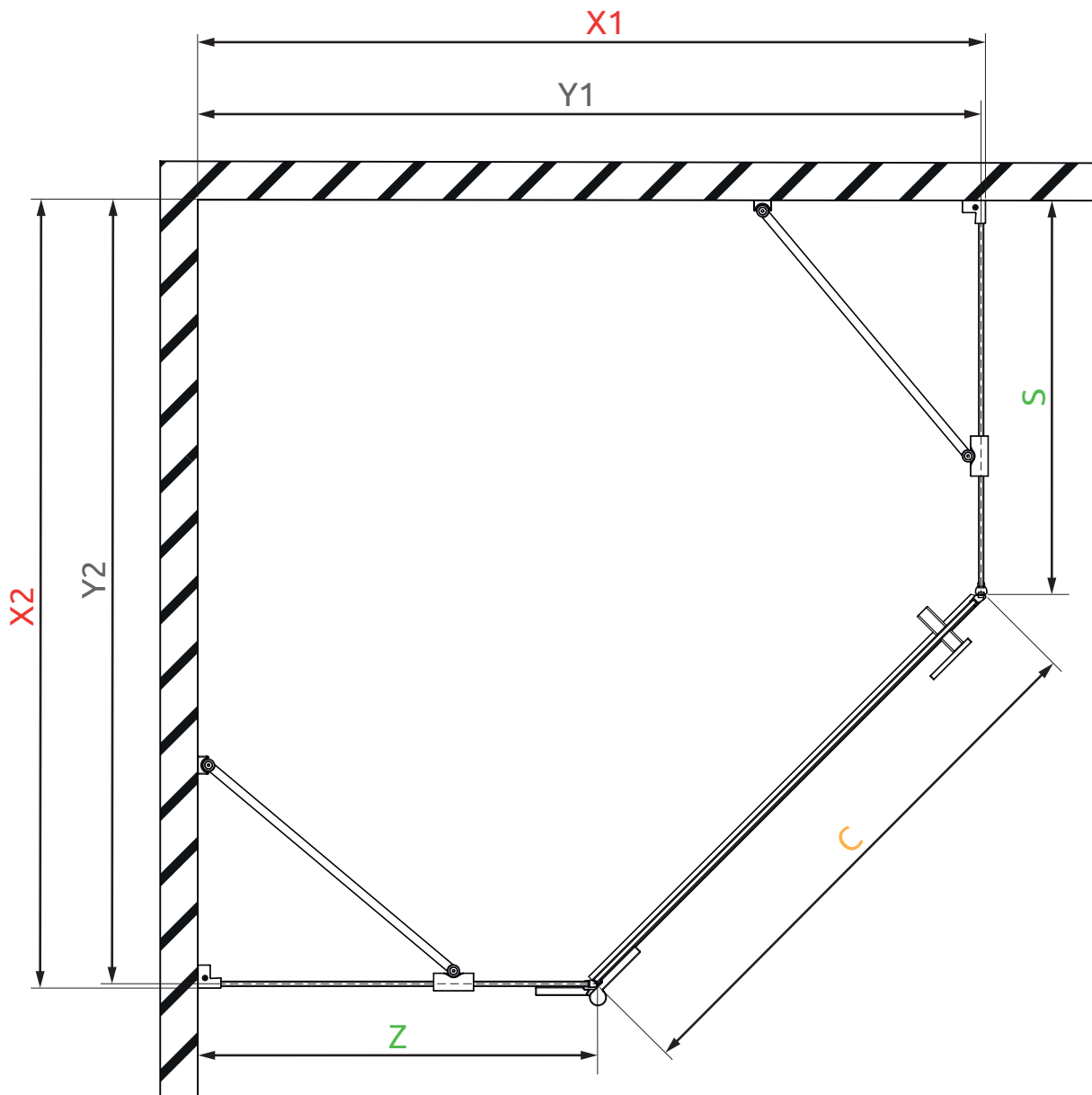

Model	X1*	X2*	Y1*	Y2*	Z*	S*	C*
PTJ 80Zx80S	777	777	772	772	345	340	610
PTJ 90Zx90S	877	877	872	872	445	440	610
PTJ 100Zx100S	977	977	972	972	545	540	610
PTJ 80Zx90S	777	877	772	872	345	440	610
PTJ 80Zx100S	777	977	772	972	345	540	610
PTJ 90Zx80S	877	777	872	772	445	340	610
PTJ 90Zx100S	877	977	872	972	445	540	610
PTJ 100Zx80S	977	777	972	772	545	340	610
PTJ 100Zx90S	977	877	972	872	545	440	610

*Wymiary dotyczą montażu typowej kabiny montowanej zgodnie z instrukcją montażu
 *All dimensions refer to standard shower installation in accordance with the assembly instruction

